

Ultra Intensity Coaxial Line Scan Light OPT-LSSC series

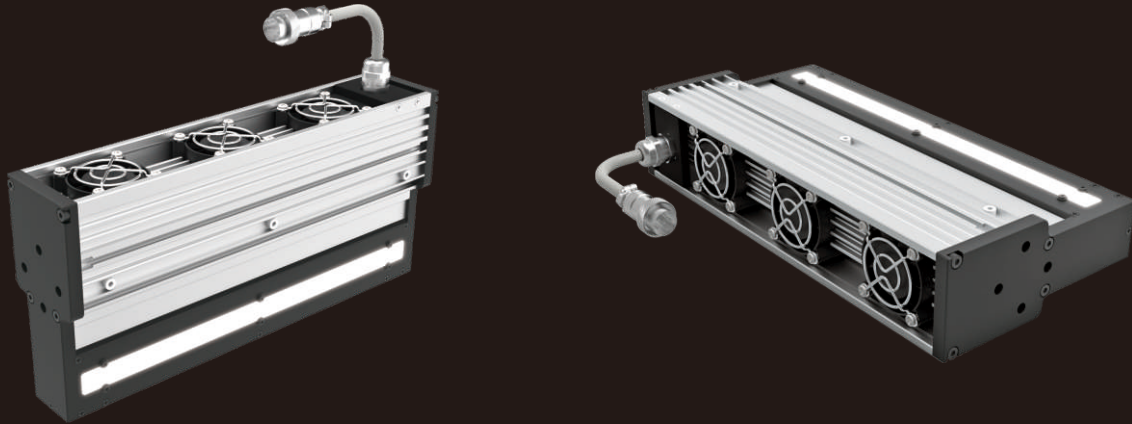

Product Features

- 1 With ultra intensity, suitable for high speed on-line inspection
- 2 Compatible to inspection of both high reflective and non-reflective surfaces
- 3 Suitable for different working distance due to ultra focused light spot,

Application Cases

- ◆ Providing illumination for line scan cameras
- ◆ Film and glass surface scratches and inside impurities inspection
- ◆ High speed printing quality inspection

Selection Guide

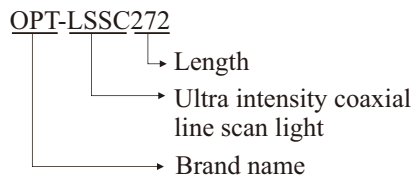

Customization Options

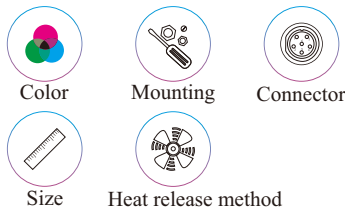
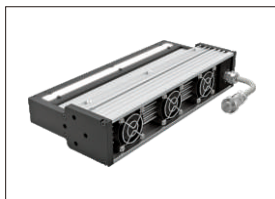

Section Structure Drawing

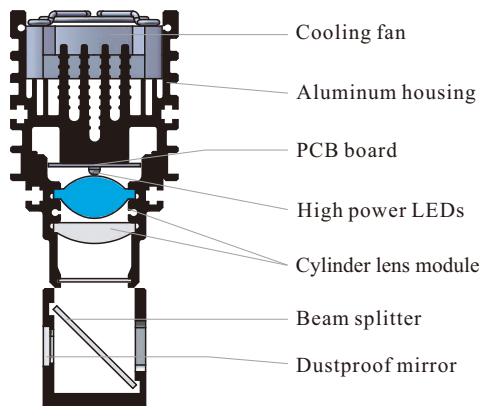

Spectrum Chart

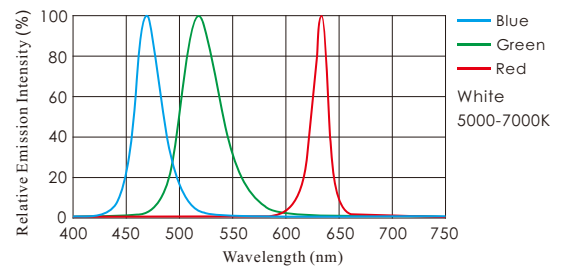

Remarks: data above is only for your reference. It may be different in applications

Relative Emission Intensity Distribution

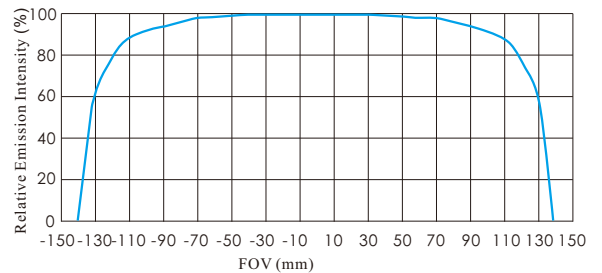

Remarks: data above is the testing result of OPT-LSSC300-R at 20mm WD, only for your reference.

Light Spot and Illuminance at different WD

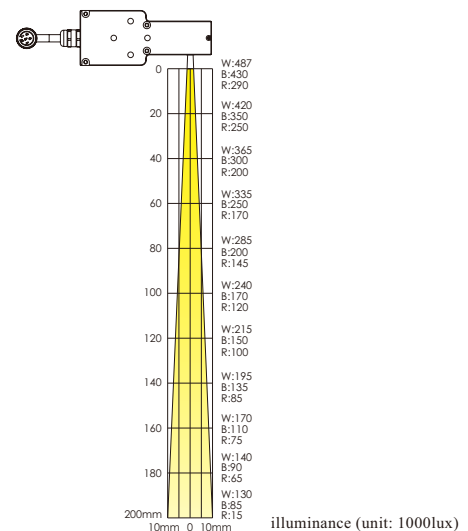

The data is from experiment, only for your reference
For lower intensity, please refer to OPT-LSGC

Model Table

No.	Model	Color	Output	Channels	Recommended Controller	Length A(mm)	Emitting Surface B(mm)
1	OPT-LSSC104	○●●	1.4A/33.6W	1	OPT-DPA6024 OPT-APA6024	104	84
2	OPT-LSSC146	○●●	2.1A/50.4W	1	OPT-DPA6024 OPT-APA6024	146	126
3	OPT-LSSC188	○●●	2.8A/67.2W	1	OPT-DPA6024 OPT-APA6024	188	168
4	OPT-LSSC230	○●●	3.5A/84W	1	OPT-DPA6024 OPT-APA6024	230	210
5	OPT-LSSC272	○●●	4.2A/100.8W	1	OPT-DPA6024 OPT-APA6024	272	252
6	OPT-LSSC314	○●●	4.9A/117.6W	1	OPT-DPA6024 OPT-APA6024	314	294
7	OPT-LSSC356	○●●	5.6A/134.4W	2	OPT-DPA6024 OPT-APA6024	356	336
8	OPT-LSSC398	○●●	6.3A/151.2W	2	OPT-DPA6024 OPT-APA6024	398	379
9	OPT-LSSC440	○●●	7A/168W	2	OPT-DPA6024 OPT-APA6024	440	420
10	OPT-LSSC482	○●●	7.7A/184.8W	2	OPT-DPA6024 OPT-APA6024	482	462
11	OPT-LSSC524	○●●	8.4A/201.6W	2	OPT-DPA6024 OPT-APA6024	524	504

No.	Model	Color	Output	Channels	Recommended Controller	Length A(mm)	Emitting Surface B(mm)
1	OPT-LSSC132	●	1.4A/33.6W	1	OPT-DPA6024 OPT-APA6024	132	102
2	OPT-LSSC188	●	2.1A/50.4W	1	OPT-DPA6024 OPT-APA6024	188	168
3	OPT-LSSC244	●	2.8A/67.2W	1	OPT-DPA6024 OPT-APA6024	244	224
4	OPT-LSSC300	●	3.5A/84W	1	OPT-DPA6024 OPT-APA6024	300	280
5	OPT-LSSC356	●	4.2A/100.8W	1	OPT-DPA6024 OPT-APA6024	356	336
6	OPT-LSSC412	●	4.9A/117.6W	1	OPT-DPA6024 OPT-APA6024	412	392
7	OPT-LSSC468	●	5.6A/134.4W	2	OPT-DPA6024 OPT-APA6024	468	448
8	OPT-LSSC524	●	6.3A/151.2W	2	OPT-DPA6024 OPT-APA6024	524	504

Customizable length

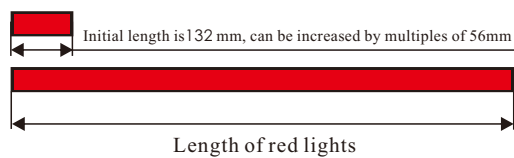
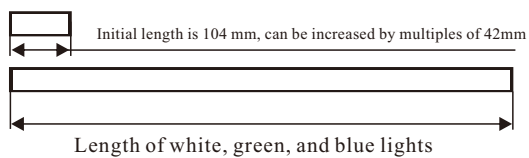

Application Example

Transparent glass surface scratches inspection

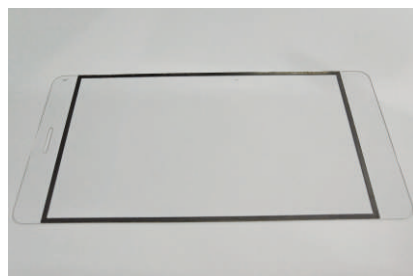

Original Image

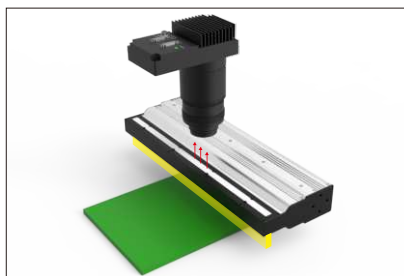

Illuminated



Result Image

Dimensional Drawing (mm)

